

Note : The pictures in the Product Specification are for reference only, please refer to the actual product.

PRODUCT SPECIFICATION

SILICONE NEON STRIP

- Top View

SAUNA



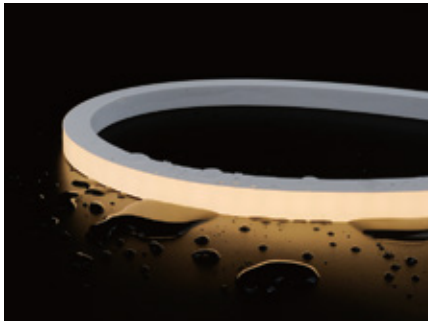

- Using Dow Corning's high light transmittance, environmentally friendly silicone material, co-extrusion molding process, with heat and moisture resistance, can withstand high temperature and humid environment, specially designed for sauna environment;
- IP67 waterproof, ensure durability, prevent dust and water from entering, in the steam and heat, the lamp strip can continue to effectively illuminate the sauna space;
- Low voltage power supply, high safety;
- Using Lumileds leds, excellent performance, high temperature environment can also maintain stable work;
- A variety of colors are available, which can be compatible with the intelligent control system to achieve remote control and automatic adjustment, helping to create a peaceful and relaxing atmosphere, relieve stress and enhance the sauna experience;
- Ambient temperature: -25 C~105 C, three-year warranty.

Dimension structure (Unit: mm)

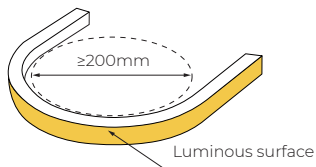
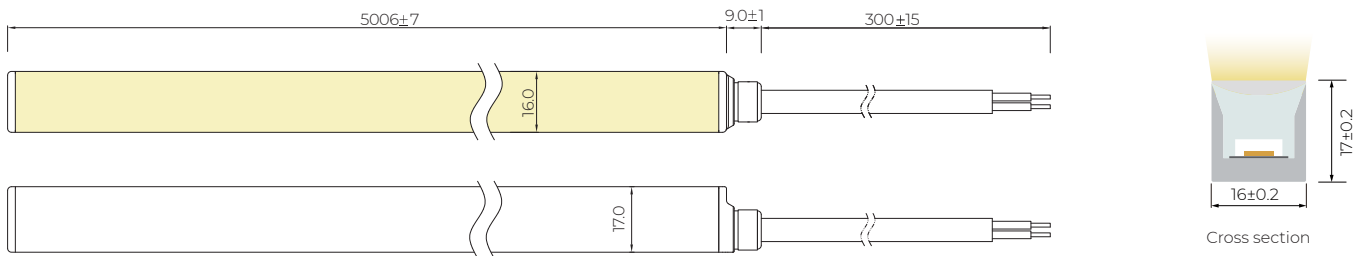

Min Bending diameter

Electrical Parameter

Voltage	LED PIN Temperature	Storage Temperature	Ambient Temperature
DC24V	Max. 120 C	-25 C ~ 60 C	Min. -25°C Max(Table below)

Specification

Power (w/m)	Efficacy (lm/w) @4000K	Max Ambient Temperature
5	CV : 95.5 CC : 76	105 C

Due to the tolerance of the production and electrical components, output value and electrical power can vary up to 10%

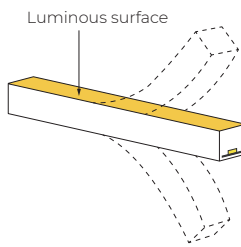

Bend vertical only

Length Standard

Length Range (M)	Final Length (mm)		Tolerance (mm)
	Integral end cap		
0<Neon Strip(L)≤5	L+6		±7
5<Neon Strip(L)≤10	L+6		±10
10<Neon Strip(L)≤15	L+6		±13
15<Neon Strip(L)≤20	L+6		±16
20<Neon Strip(L)≤25	L+6		±19

Light Distribution Curve

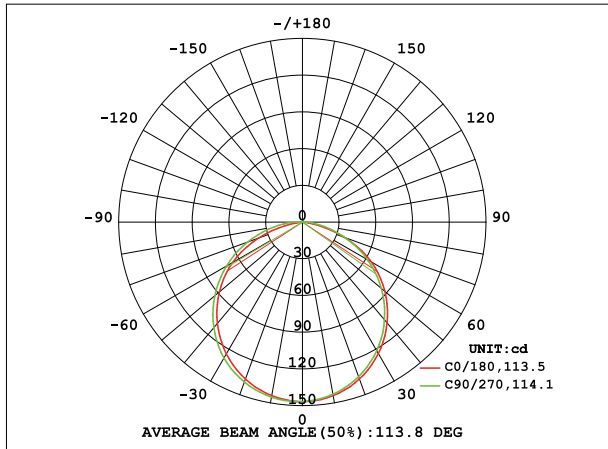

Illuminance curve

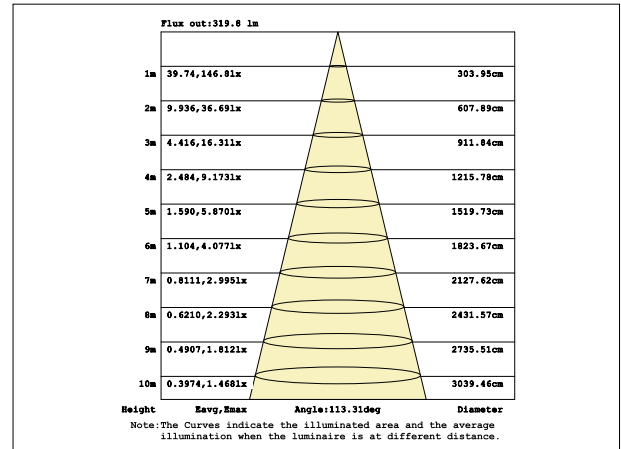

Note: The above data is based on 24V, 5W/M, single colour with 4000k colour temperature. If you need IES files for other types. Please contact our sales department.

Parameter Table

Horizontal Bending

Vertical Bending

Consistency One Bin

Resistant Saltwater

Resistant To Solvents

UV Protection

Warranty 3 Years

IK 10

IP 67

Single color (CV)

CCT(K)	SDCM	Ra	Voltage	Power(W)	Lumen (LM/M)	Efficiency (LM/W)	Unit Length (mm)	Max. Run Length (M)	CC/CV
2700	≤3	≥90	DC24V	5	431	86.2	50	10	CV
3000	≤3	≥90	DC24V	5	432	86.4	50	10	CV
3500	≤3	≥90	DC24V	5	468	93.6	50	10	CV
4000	≤3	≥90	DC24V	5	478	95.5	50	10	CV
5000	≤4	≥90	DC24V	5	478	95.6	50	10	CV
6500	≤5	≥90	DC24V	5	469	93.7	50	10	CV

Single color (CC)

CCT(K)	SDCM	Ra	Voltage	Power(W)	Lumen (LM/M)	Efficiency (LM/W)	Unit Length (mm)	Max. Run Length (M)	CC/CV
2700	≤3	≥90	DC24V	5	359	71.7	50	24	CC
3000	≤3	≥90	DC24V	5	376	75.2	50	24	CC
3500	≤3	≥90	DC24V	5	364	72.7	50	24	CC
4000	≤3	≥90	DC24V	5	380	76.0	50	24	CC
5000	≤4	≥90	DC24V	5	386	77.2	50	24	CC
6500	≤5	≥90	DC24V	5	380	75.9	50	24	CC

- The maximum series length refers to the maximum length of the light strip with single-end power supply in series under the standard 30CM cable.
- The given color temperature is the temperature of finished product.
- The given data are typical values due to the tolerances of the production process and the electrical components, values for light output and electrical power can vary up to 10%.
- All products can be dimmed; the dimmer's voltage should conform to the rated voltage of the led light.
- The output frequency of the dimmer of the constant-current led light should be less than 2K Hz, and the output PWM can control the led light.

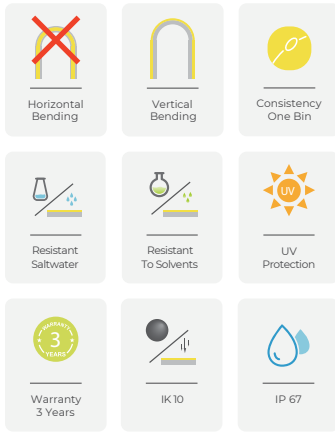

- The maximum series length refers to the maximum length of the light strip with single-end power supply in series under the standard 30CM cable.
- The given color temperature is the temperature of finished product.
- The given data are typical values due to the tolerances of the production process and the electrical components, values for light output and electrical power can vary up to 10%.
- All products can be dimmed; the dimmer's voltage should conform to the rated voltage of the led light.
- The output frequency of the dimmer of the constant-current led light should be less than 2K Hz, and the output PWM can control the led light.

CCT Tunable

CCT(K)	Ra	Voltage	Power(W)	Lumen (LM/M)	Efficiency (LM/W)	Unit Length (mm)	Max. Run Length (M)	CC/CV
2700 ±150	≥90	DC24V	5	414	82.7	71.4	5	CV
6500 ±500	≥90	DC24V	5	449	89.8	71.4	5	CV
2700+6500	≥90	DC24V	5	448	89.6	71.4	5	CV

RGBW

CCT(K)	Ra	Voltage	Power(W)	Lumen (LM/M)	Efficiency (LM/W)	Unit Length (mm)	Max. Run Length (M)	CC/CV
R	--	DC24V	2.5	88	35.0	83.3	5	CV
G	--	DC24V	2.5	271	108.4	83.3	5	CV
B	--	DC24V	2.5	52	20.7	83.3	5	CV
W : 2700 ⁺¹⁰⁰ ₋₂₀₀	≥80	DC24V	2.5	222	88.9	83.3	5	CV
RGBW	--	DC24V	10	640	64.0	83.3	5	CV

CCT(K)	Ra	Voltage	Power(W)	Lumen (LM/M)	Efficiency (LM/W)	Unit Length (mm)	Max. Run Length (M)	CC/CV
R	--	DC24V	2.5	85	34.1	83.3	5	CV
G	--	DC24V	2.5	223	89.3	83.3	5	CV
B	--	DC24V	2.5	53	21.3	83.3	5	CV
W : 3000 ⁺⁵⁰ ₋₂₅₀	≥80	DC24V	2.5	230	91.9	83.3	5	CV
RGBW	--	DC24V	10	589	58.9	83.3	5	CV

CCT(K)	Ra	Voltage	Power(W)	Lumen (LM/M)	Efficiency (LM/W)	Unit Length (mm)	Max. Run Length (M)	CC/CV
R	--	DC24V	2.5	73	29.3	83.3	5	CV
G	--	DC24V	2.5	243	97.3	83.3	5	CV
B	--	DC24V	2.5	53	21.2	83.3	5	CV
W : 3200 ⁺²⁵⁰ ₋₁₅₀	≥80	DC24V	2.5	235	93.8	83.3	5	CV
RGBW	--	DC24V	10	603	60.3	83.3	5	CV

CCT(K)	Ra	Voltage	Power(W)	Lumen (LM/M)	Efficiency (LM/W)	Unit Length (mm)	Max. Run Length (M)	CC/CV
R	--	DC24V	2.5	86	34.5	83.3	5	CV
G	--	DC24V	2.5	276	110.2	83.3	5	CV
B	--	DC24V	2.5	57	22.9	83.3	5	CV
W : 3700±250	≥80	DC24V	2.5	239	95.5	83.3	5	CV
RGBW	--	DC24V	10	663	66.3	83.3	5	CV

CCT(K)	Ra	Voltage	Power(W)	Lumen (LM/M)	Efficiency (LM/W)	Unit Length (mm)	Max. Run Length (M)	CC/CV
R	--	DC24V	2.5	77	30.6	83.3	5	CV
G	--	DC24V	2.5	234	93.7	83.3	5	CV
B	--	DC24V	2.5	50	20.1	83.3	5	CV
W : 4500±300	≥80	DC24V	2.5	222	88.9	83.3	5	CV
RGBW	--	DC24V	10	582	58.2	83.3	5	CV

CCT(K)	Ra	Voltage	Power(W)	Lumen (LM/M)	Efficiency (LM/W)	Unit Length (mm)	Max. Run Length (M)	CC/CV
R	--	DC24V	2.5	82	32.6	83.3	5	CV
G	--	DC24V	2.5	253	101.0	83.3	5	CV
B	--	DC24V	2.5	52	20.7	83.3	5	CV
W : 5700±500	≥80	DC24V	2.5	228	91.1	83.3	5	CV
RGBW	--	DC24V	10	619	61.9	83.3	5	CV

Cable Entry (Unit: mm)

Integral End Cap (IP67)

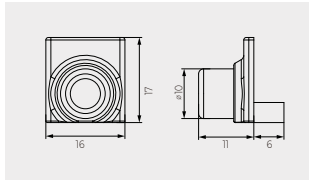

Front Cable Entry

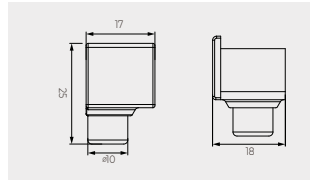

Side Cable Entry

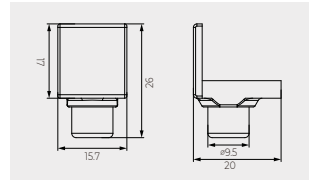

Bottom Cable Entry

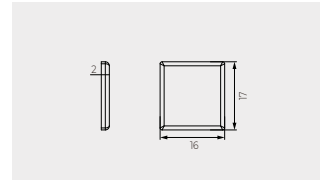

Closed End cap

Cable

Cable Type	Schematic Diagram	Specification	Core	Electrical Properties
Silicone Cable		OD: 6.0mm / Inner core: 20AWG	●●	Red V+, Black V-
		OD: 6.0mm / Inner core: 20AWG	●○●	Black V+, White W, Yellow WW
		OD: 6.4mm / Inner core: Red/Black--20AWG Green/Blue/White--22AWG	●○●●●	Black V+, White W, Blue B, Green G, Red R
Waterproof Connector with Silicone Cable		OD: 6.0mm / Inner core: 20AWG M12Male / Female connecto	●●	Red V+, Black V-
		OD: 6.0mm / Inner core: 20AWG M12Male / Female connecto	●○●	Black V+, White W, Yellow WW
		OD: 6.4mm / Inner core: Red/Black--20AWG Green/Blue/White--22AWG M12Male / Female connecto	●○●●●	Black V+, White W, Blue B, Green G, Red R

Cutting Mark



Remark:
the black marker is the cutting position



Use professional scissors to cut vertically at the cutting mark

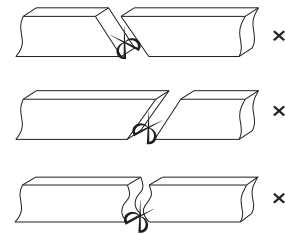

Please don't be feel free to cut and cut into an oblique angle or cambered section.

Accessories (Unit: mm)

PC Profile

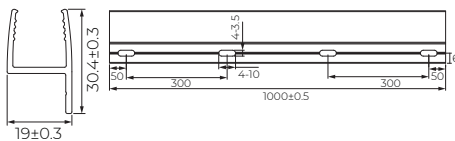

Length: 1000X19X30.4
Accessories:
Screw M3X16 (SUS304)

PC Profile

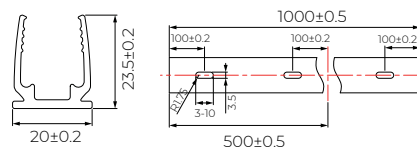

Length: 1000X20X23.5
Accessories:
Screw M3X16 (SUS304)

PC Clip

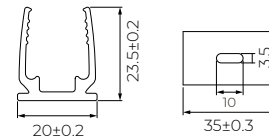

Length: 35X20X23.5
Accessories:
Screw M3X16 (SUS304)

Single Color Connection Diagram

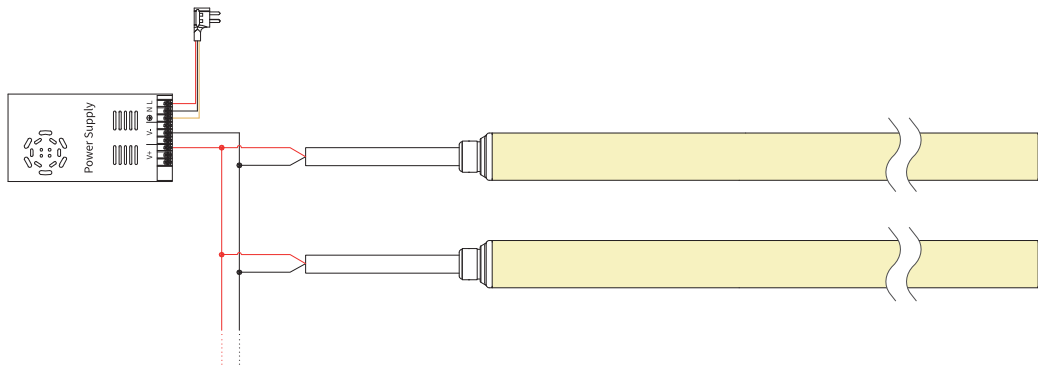

Tunable white Connection Diagram

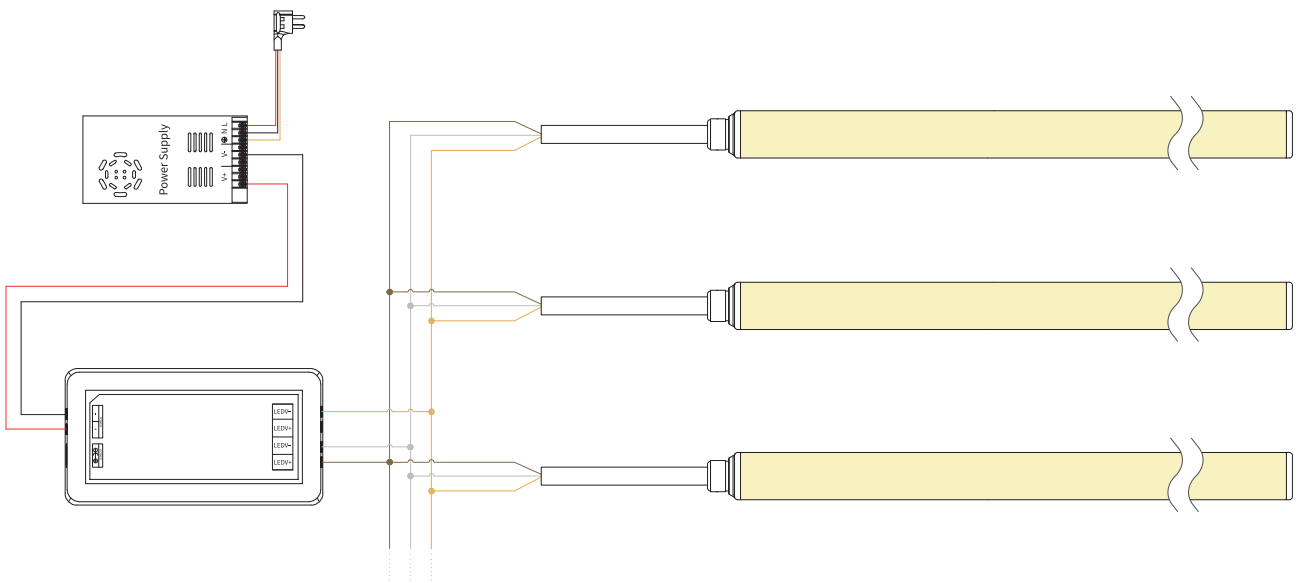

RGBW Connection Diagram

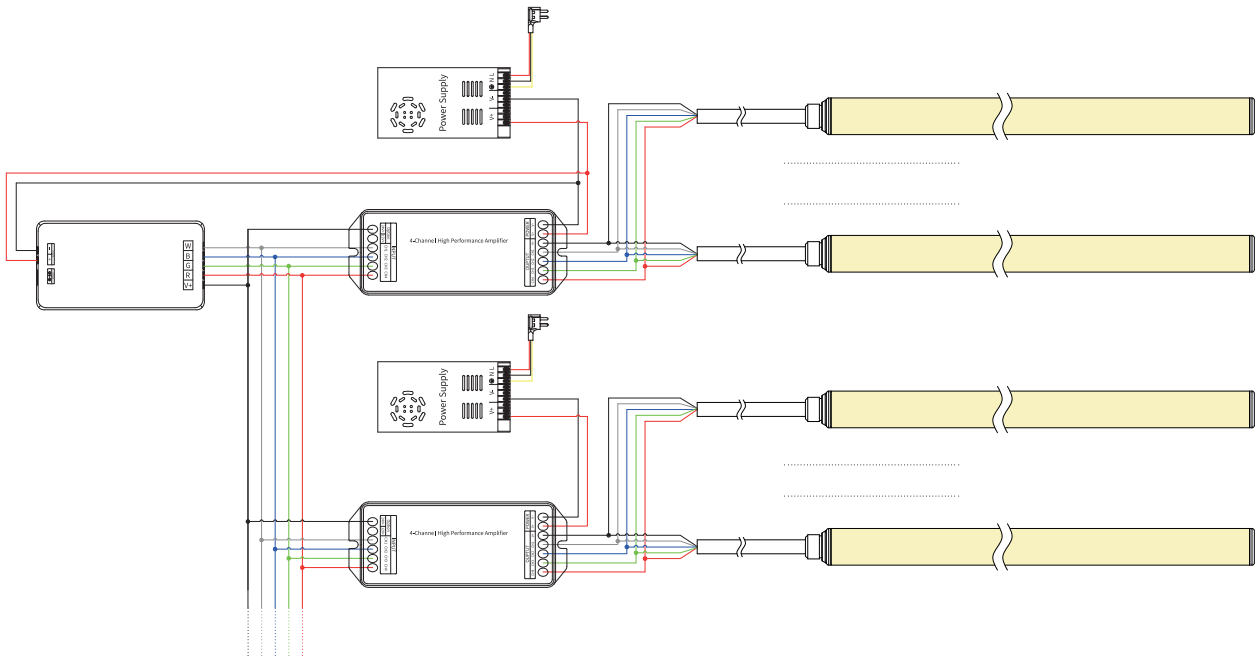

Installation Precautions

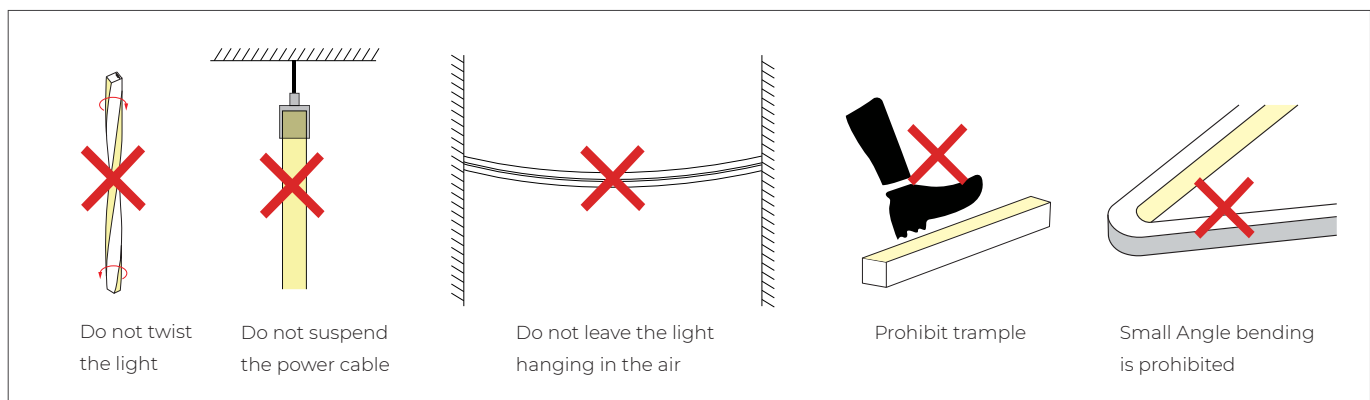
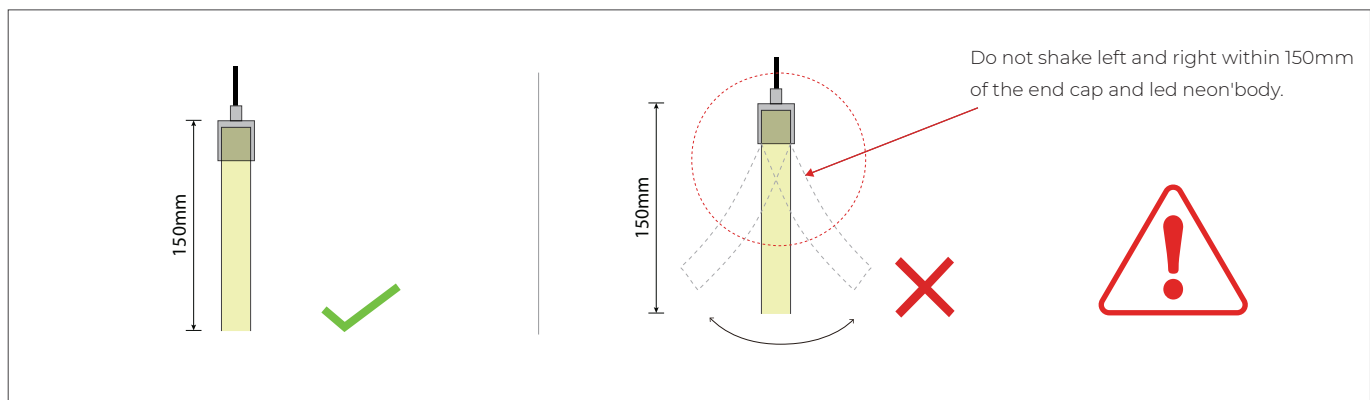

Put it in the profile

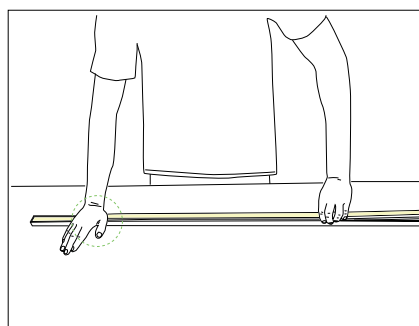

- Please press the led strip with your palm to slowly insert the led strip into the groove, and gently straighten the led strip above the groove with your right hand.
- Try to keep the led strip in a flat state during the installation process.

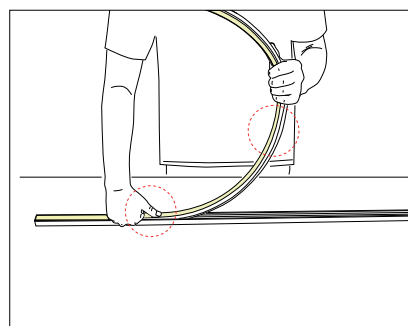

- Do not press the led strip with a single finger, it is easy to damage the internal parts of the led strip.
- The bent arc of the led strip should not be too large during installation.

Installation Precautions -- Side Mounted

(If the length of the light is more than 2 meters, two persons must work together to install it.)

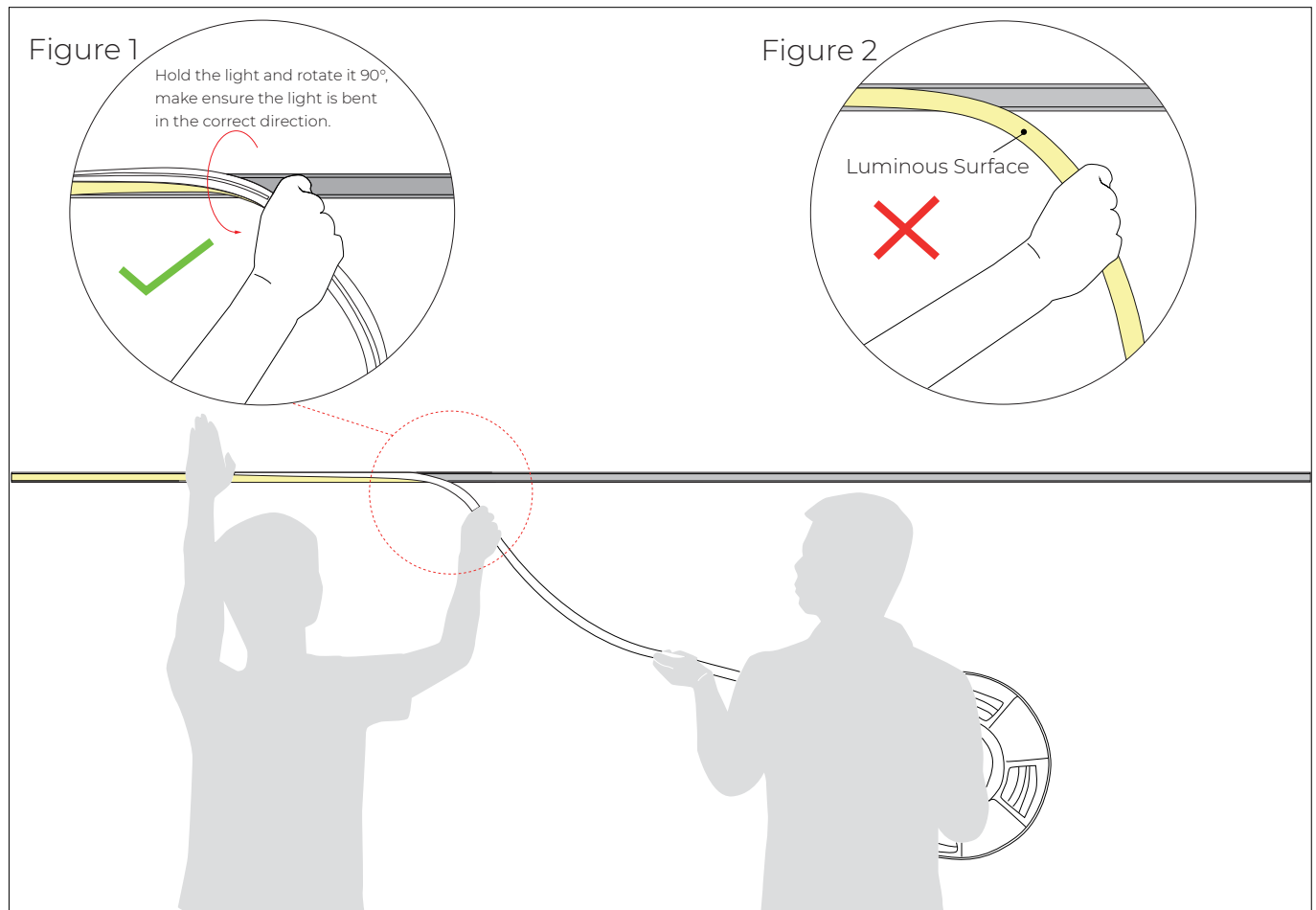

1.Installer:

- Press the light with the palm of the left hand to slowly load it into the slot. Straighten the light with right hand, hold it and rotate it 90 ° to droop it in the direction of your hand. See Figure 1.
- Do not bend the luminous surface to the side. See Figure 2.

2.Assistant:

- Cooperate with the installer to lift the reel of the light, and then slowly deliver the light to installer. Do not pull or twist the light during the installation.

Installation Precautions -- Side Mounted

(If the length of the light is more than 5 meters, two persons must work together to install it.)

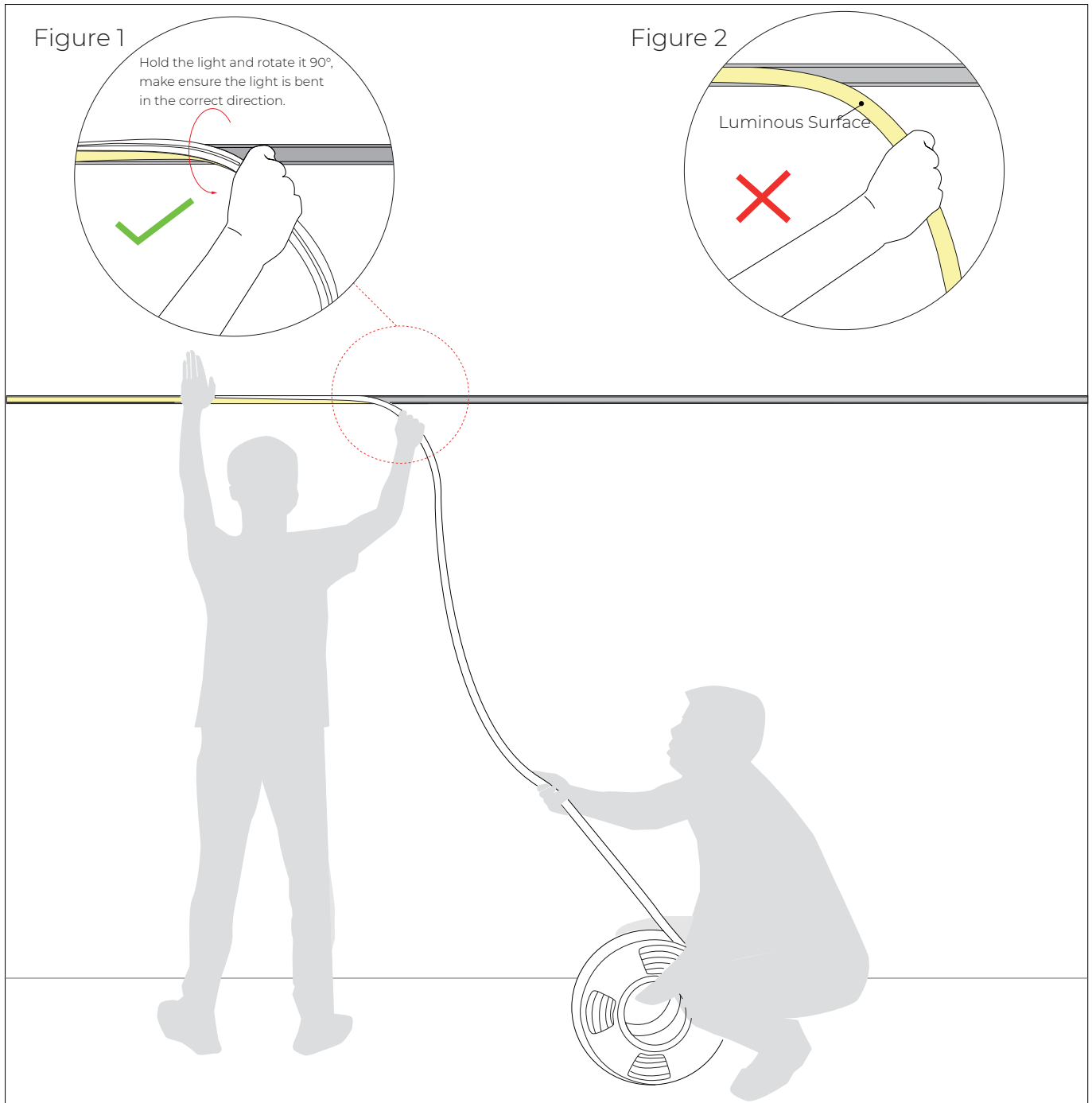

Figure 1

Hold the light and rotate it 90°, make ensure the light is bent in the correct direction.

Figure 2

Luminous Surface

1.Installer:

-Press the light with the palm of the left hand to slowly load it into the slot. Straighten the light with right hand, hold it and rotate it 90 ° to droop it in the direction of your hand. See Figure 1.

-Do not bend the luminous surface to the side. See Figure 2.

2.Assistant:

-Cooperate with the installer to slowly deliver the light to installer. Do not pull or twist the light during the installation.

Installation Precautions -- Top Mounted

(If the length of the light is more than 2 meters, two persons must work together to install it.)

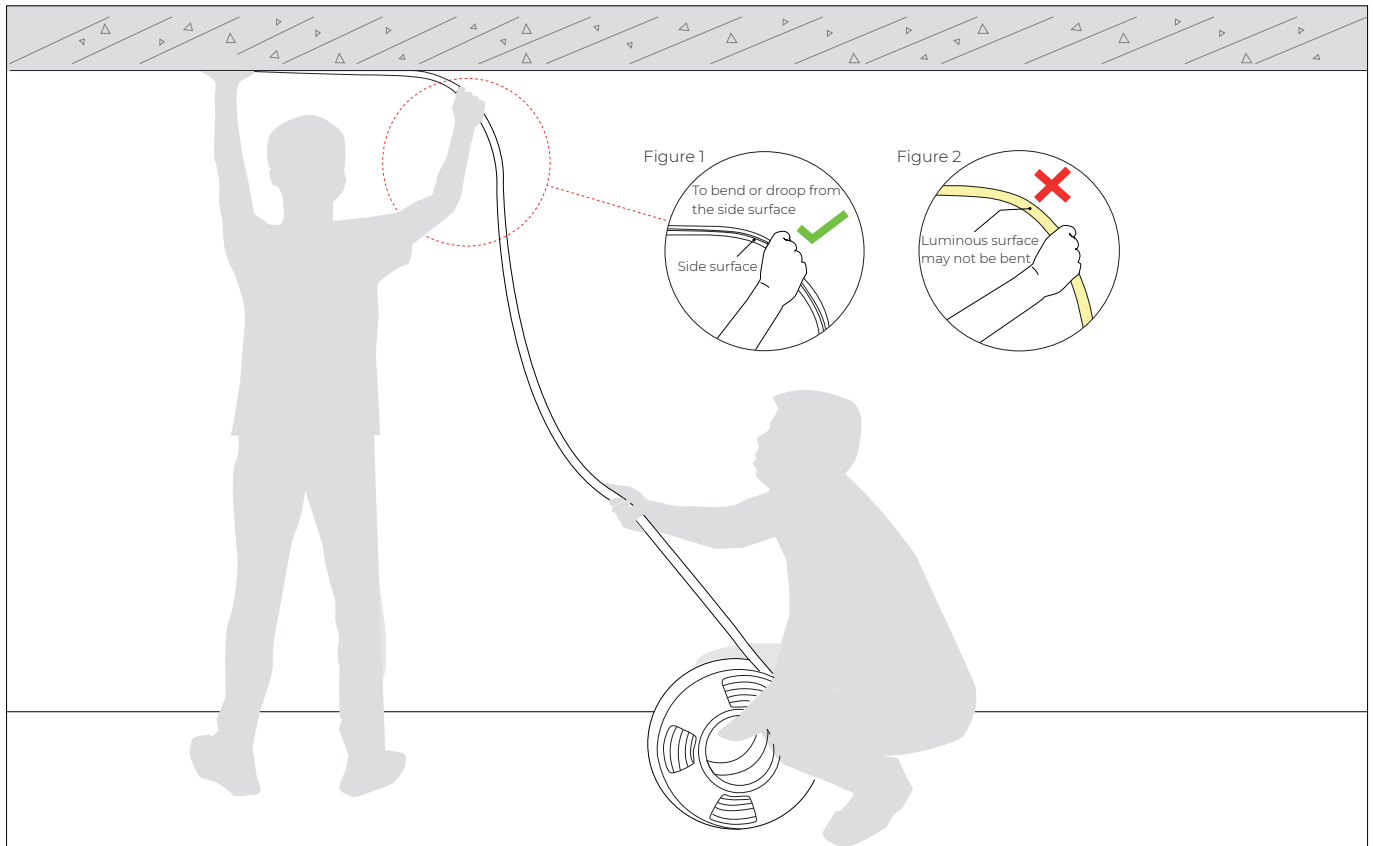

1.Installer:

- Press the light with the palm of the left hand to slowly load it into the slot. Straighten the light with your right hand so that it droop naturally. See Figure 1.
- Luminous surface may not be bent. See Figure 2.

2.Assistant:

- Cooperate with the installer to slowly deliver the light to installer. Do not pull or twist the light during the installation.

Notes

The selection of the cable specification at the output end of the power supply, it depends on the total current of the load and the length of the cable. It is recommended to select according to the following table:

Current of the light	Specifications of the cable								
	L=1M	L=2M	L=4M	L=6M	L=8M	L=10M	L=12M	L=14M	L=16M
1A	AWG26	AWG23	AWG21	AWG18	AWG18	AWG17	AWG16	AWG15	AWG15
2A	AWG23	AWG21	AWG18	AWG16	AWG15	AWG14	AWG13	AWG12	AWG12
3A	AWG22	AWG18	AWG16	AWG14	AWG13	AWG12	AWG11	AWG11	AWG10
4A	AWG21	AWG18	AWG15	AWG13	AWG12	AWG11	AWG10	AWG9	AWG9
5A	AWG20	AWG17	AWG14	AWG12	AWG11	AWG10	AWG9	AWG9	AWG8
6A	AWG18	AWG16	AWG13	AWG11	AWG10	AWG9	AWG8	AWG8	AWG7
7A	AWG18	AWG15	AWG12	AWG11	AWG9	AWG8	AWG8	AWG7	AWG6
8A	AWG17	AWG15	AWG12	AWG10	AWG9	AWG8	AWG7	AWG7	AWG6
9A	AWG17	AWG14	AWG11	AWG10	AWG8	AWG7	AWG7	AWG6	AWG5
10A	AWG16	AWG14	AWG11	AWG9	AWG8	AWG7	AWG6	AWG6	AWG5

- ※ The unused light should be sealed with the packaging bag to avoid prolonged exposure.
- ※ Please use DC24V isolated constant voltage power supply with ripple voltage less than 5%. Using other types of power supply may damage the light or cause other safety risks.
- ※ In practical application, 20% allowance should be reserved for power supply to ensure the stability of power supply.
- ※ It is recommended that professionals connect the power supply. Do not connect the power supply with live power to avoid electric shock.
- ※ Please confirm whether the voltage of the power supply is consistent with the voltage of the light; Pay attention to the positive and negative poles of the power cord, do not connect wrong, so as not to cause product damage;
- ※ When multiple power supplies are used, ensure that the positive poles of the power supply are not connected in parallel. Otherwise, the power supply system may be unstable or damaged after long-term operation.
- ※ If the actual application length exceeds the specified length, it will lead to overload, heating and uneven brightness of the light.
- ※ During installation, please do not scratch, twist, or bend the light irregularly. Otherwise, the light may be damaged beyond repair.
- ※ To ensure the life and reliability of the light, please do not over bend the light, which will damage the product itself.
- ※ To protect your eyes, please avoid staring at the glowing surface of the light for a long time.
- ※ Non-professionals are forbidden to install, disassemble and maintain the product.
- ※ Do not use any acid or alkaline adhesive to fix the light (including but not limited to glass glue, etc.)
- ※ IP67 products are not suitable for long-term immersion in water; IP68 products are only customized by the factory. After cutting and processing by users themselves, there is a risk that IP68 protection level cannot be reached
- ※ Because of the difference in structure, even if the same color temperature value, different sizes of light will look slightly different colors. Please confirm it before use.

Tests showed that methanol and benzenes will have yellowing effects on silicone.

In the newly decorated interior environment, epoxy floor paint, wall paint, wallpaper adhesive, various decoration materials or new furniture, they are likely to release of methanol and benzenes.

It is recommended to remove methanol and benzenes first, or ventilate for a period of time in the newly decorated interior environment before install the silicone neon light, to avoid affecting the silicone body.

BE A TRUSTED LED STRIP MANUFACTURER



Tel: +40.749.217.807
+40.749.281.431
E-mail: comenzi@dienergy.ro

ICPE building MD5, Ground floor,
Splaiul Unirii No. 313
Bucharest, Sector 3, Romania